

Eco Preparation 1800 mm Soaking Sink for Dishwasher with 2 Bowls - Left drain

ITEM # _____

MODEL # _____

NAME # _____

SIS # _____

AIA # _____

132939 (EDBD1817L)

 Sink Unit for Dishwasher with
 2 bowls left hand drainer
 500x500, 1800mm

Short Form Specification

Item No. _____

Worktop in 304 AISI stainless steel with front edge h=40mm. Rear upstand h=100mm. N.2 bowls 500x500mm. Front and side covering panels in stainless steel. Rear panel in stainless steel. Square section legs 40x40mm in stainless steel with adjustable feet. An undercounter dishwasher can be placed under the drainer.

Main Features

- Sturdiness, stability and reliability of table accurately tested.

Construction

- Constructed entirely in stainless steel to offer maximum durability.
- Bottom part of drain left free to house an undercounter dishwasher.
- Wide range of taps are available to suit every need.
- Drainage area suitable for drying operations

Optional Accessories

- Double plastic drain syphon 1,5" PNC 850021
- Lower shelf for 1200mm tables and sinks and for 1800 mm undercounter dishwasher sinks PNC 855145
- 3-sided underframe for 1200mm tables PNC 855152
- Wheel kit for cupboards, 4 wheels (2 with brakes), D=100 mm PNC 855299
- Single plastic drain syphon 1,5" for work tables with bowl PNC 855306
- Elbow operated mixer tap with spout 3/4", single hole PNC 855322
- Elbow operated mixer tap with short spout 3/4", single hole PNC 855323
- Maxi reel retractable hose spray unit, 6m PNC 855327
- Foot operated mixer tap (hot and cold) with spout 3/4" PNC 855328

APPROVAL: _____

Key Information:

External dimensions, Width:	1800 mm
132939 (EDBD1817L)	
External dimensions, Depth:	700 mm
External dimensions, Height:	900 mm
Upstand Dimensions, Height:	100 mm
Upstand Dimensions, Depth:	13 mm
Upstand Dimensions, Radius:	R=10
Bowls number	2
Bowl dimensions	500x500xH250
Net weight:	75 kg

Front

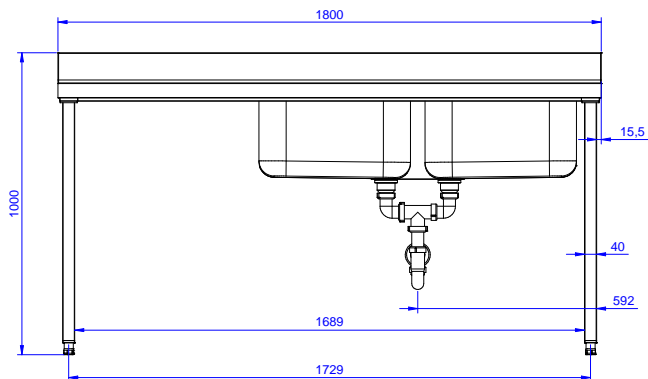

Side

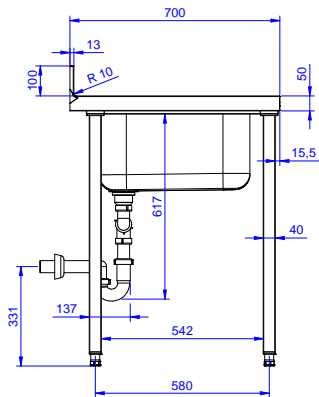

D = Drain

Top

